

GO LED Down Light

Dimmable / Networkable LED General Lighting Fixture

Model name	GDL06
Size	180mm circle (6" nominal)
Power Consumption	12 Watts (Power factor +.9)
Available CCT	3000K to 6500K (Ergonomic Color Changing Feature Available)
Illumination Data	961 Lumens@4000K, +85 CRI (80 Lumens / Watt)
Material	Aluminium housing, polycarbonate lens
Voltage	120V VAC/VDC Standard, 50~60Hz, UL Class 2 O/P, 277V optional
Warranty	3 years Limited
L70	+70,000 Calculated hours
Safety	UL Certified
Sample part number	GDL06-R-40-12W-V-120V-DW-SILVER (Please see ordering table for complete part number ordering options)

GDL06

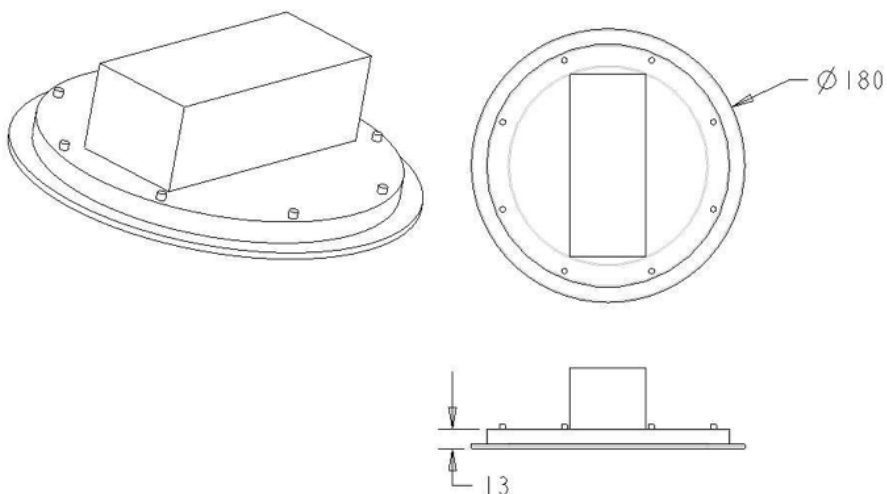

GO LED Down Light

Dimmable / Networkable LED General Lighting Fixture



Series	GDL06			
Mount Method	<p>R Recessed</p>			
CCT	<p>30 3000k (+/- ~100k)</p> <p>35 3500k (+/- ~100k)</p> <p>40 4000k (+/- ~100k)</p> <p>45 4500k (+/- ~100k)</p> <p>ER Ergonomic Color Changing Option with user-adjustable CCT range from 2700k to 6500k</p>	<p>50 5000k (+/- ~100k)</p> <p>55 5500k (+/- ~100k)</p> <p>60 6000k (+/- ~100k)</p> <p>65 6500k (+/- ~100k)</p>		
Wattage	12W	12 Watts (Standard)		
Control Type	<p>V 0 - 10V Dimming (Standard)</p> <p>L Lutron Ecosystem</p>			
Input Voltage	<p>120V 120V AC/DC (Standard)</p> <p>270V 277V AC/DC</p>			
Lens Type	DW	Diffused White (Standard)		
Body Finish	<p>WHITE</p> <p>SILVER (Standard)</p> <p>BLACK</p>	<p>* Custom Colors Available</p>		



GO LED Luminaires

Dimmable / Networkable LED General Lighting Fixture

Features

Quality

Compare GO's quality to any other manufacturer - from design and engineering to North American manufacturing and dedicated customer service, GO will stand out. And in side by side comparisons, GO products always deliver a noticeably better quality of light.

Natural Light

No flickering, no ballast noise, no EMI, UV or glare. Reduces eye strain, headaches and other workplace complaints associated with fluorescent lighting.

Dimmable

Can be dimmed with standard 0-10V wall-mount controller, IR remote control or automated sensor control. Components replaceable/upgradeable. Designed for field replaceable PCBs, power and control systems as technology becomes even more efficient. Retain the fixture, upgrade the technology.

Low Heat Generation

Low heat generation, extra saving through reduction of HVAC load.

Environment Friendly

No mercury, RoHS compliant, no disposal concern, highly robust – no glass to break and shatter.

Long Life

Reduces relamping cycle 2 to 5 times fewer than fluorescent systems – ROI <3 years typical.

Solid Construction

Robust metal construction with polycarbonate lens, sealed to resist infiltration by dust or insects and specifically designed for extra-long life.

High Uniformity

+85% consistency of luminance across planar surface.

Intelligent Lighting

Compatible with building automation systems such as Lutron Ecosystem, DALI, DMX, etc, depending on the model.

Low Profile

Can be installed in shallow plenum space, mounts flush with ceiling. Profile as low as 2.5" available.



All finished products will be shipped under NAFTA Certificate of Origin

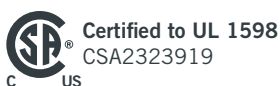

GO Lighting Technologies Inc.

5050 Dufferin Street, Unit 115 / Toronto ON M3H 5T5 / Canada
Phone: 416-679-0259 / Phone (Toll-free): 866-571-7036 / Fax: 416-679-9452
E-mail: info@goenergyeffective.com / www.goenergyeffective.com